

THIS DRAWING IS UNPUBLISHED. RELEASED FOR PUBLICATION 2011  
 © COPYRIGHT 2011 ALL RIGHTS RESERVED.

LOC		DIST		REVISIONS			
P	LTR	DESCRIPTION	DATE	DWN	APVD		
AL	2						
	G1	ECR 12-004643	17APR2012	XP	RS		

ALABEO MAX. PERMITIDO HASTA 9.2  
 PERMISSIBLE WARP TO 9.2

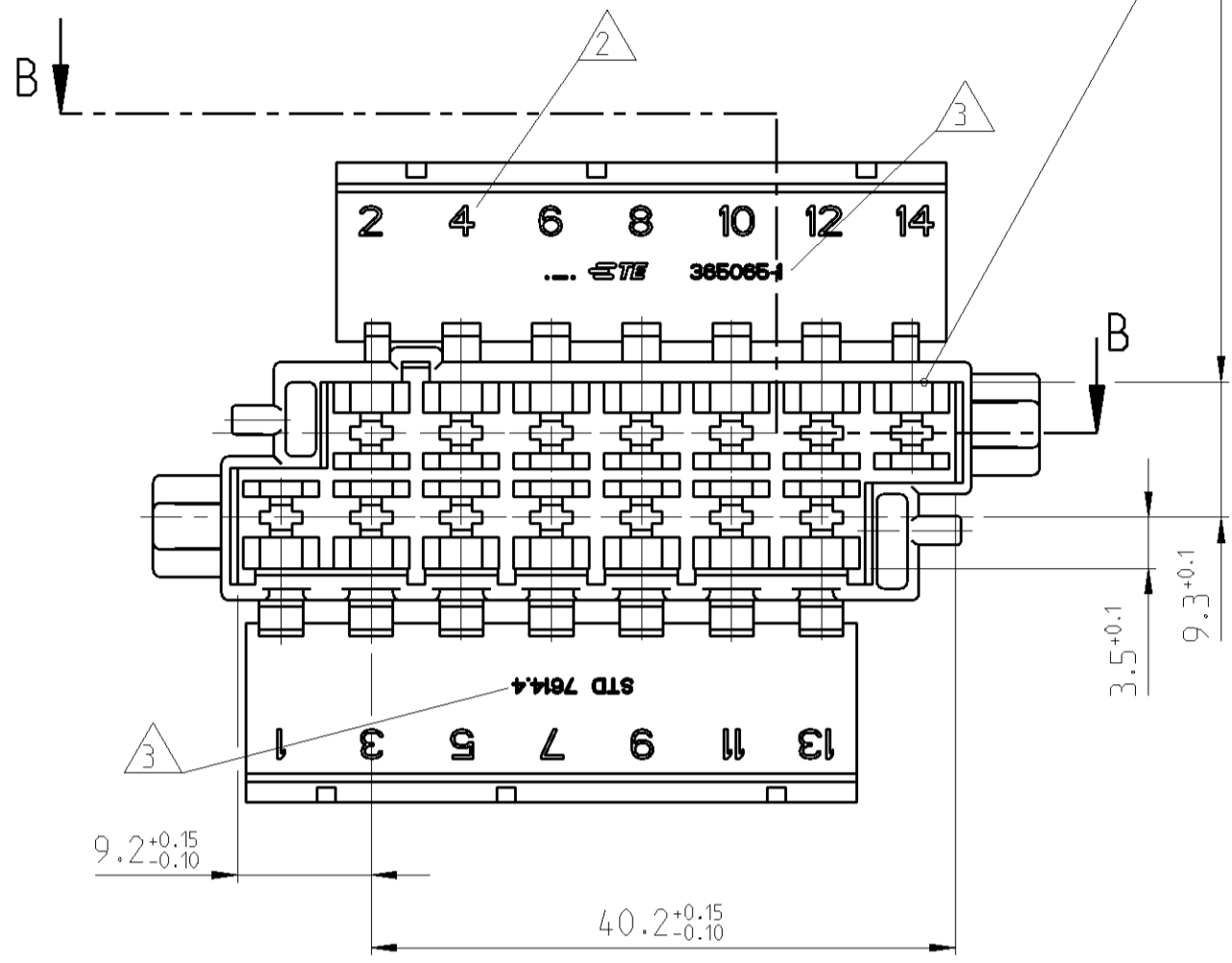

SECCION A-A SECTION

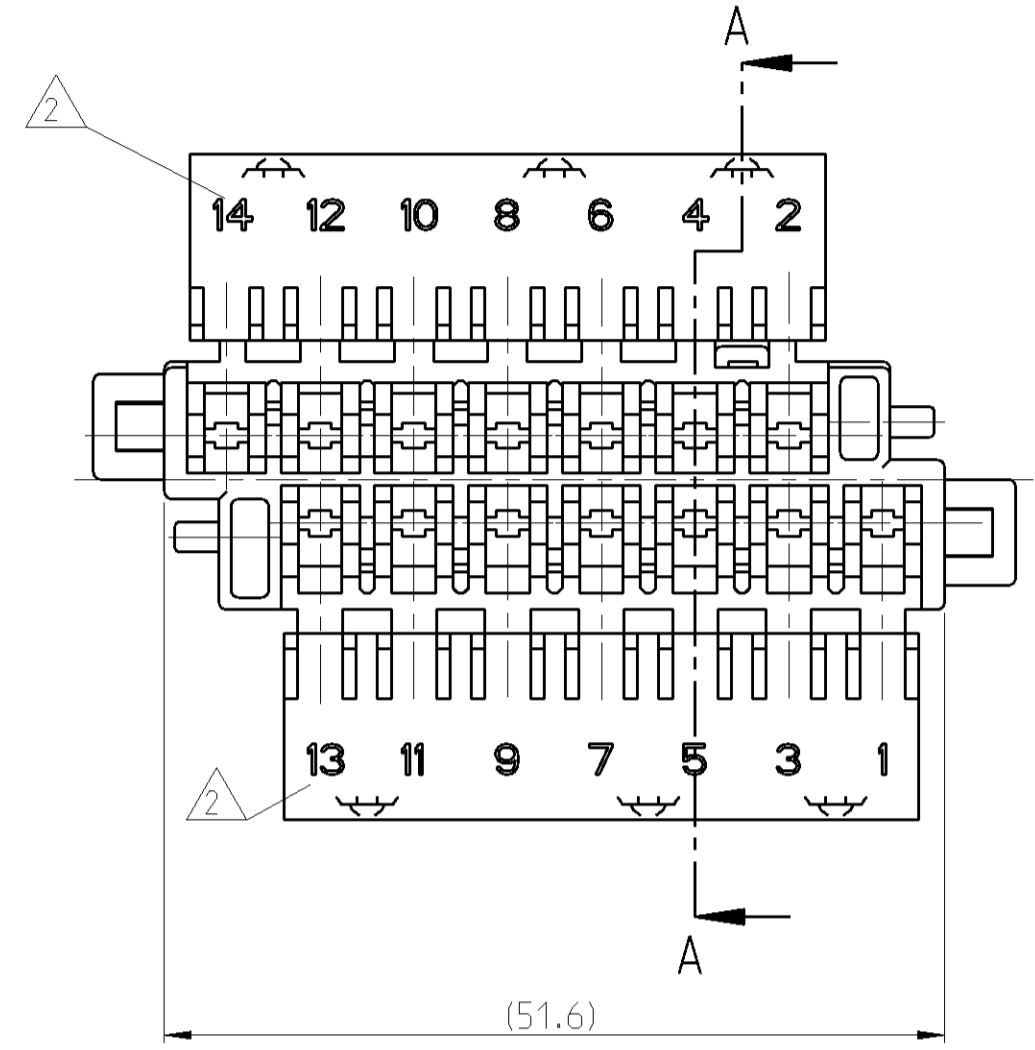
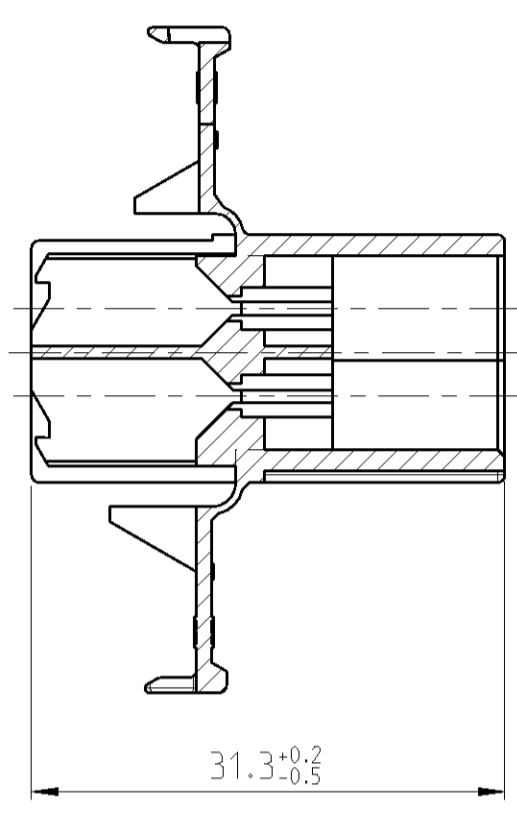

SECCION B-B SECTION

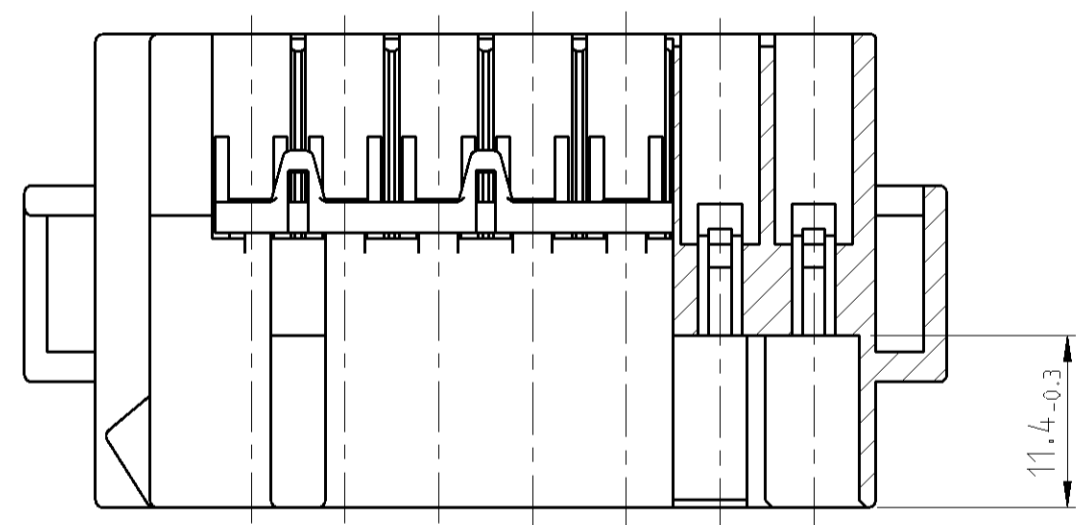

DETALLE CAJA CON BISAGRA CERRADA  
 HOUSING WITH CLOSED FLAP

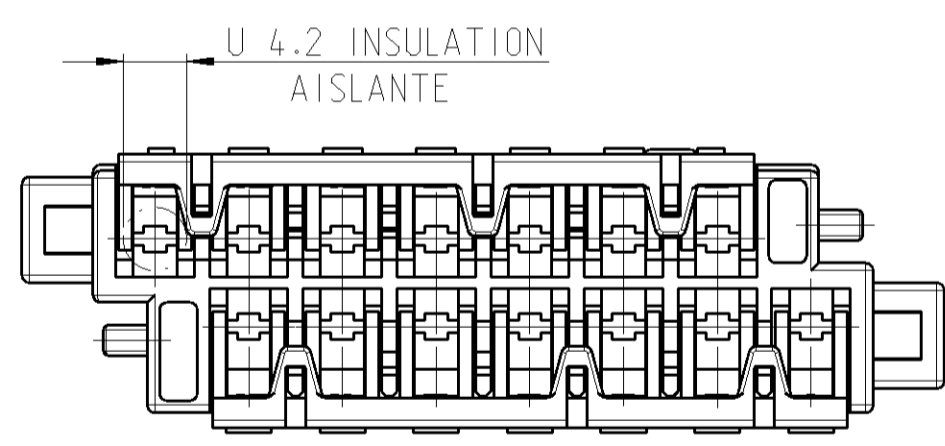

- MATERIAL Y COLORES HAN DE ESTAR LIBRES DE CADMIO  
 MATERIAL AND COLORS ARE FREE OF CADMIUM
- ALTURA LETRA 2  
 CHARACTER HEIGHT 2
- ALTURA LETRA 1  
 CHARACTER HEIGHT 1
- USAR CON 365066  
 FITTING WITH 365066
- LAS PIEZAS DEBEN IR EMPAQUETADAS HERMETICAMENTE  
 Y SU CONTENIDO DE HUMEDAD DEBE SER 2.5±1%  
 PARTS MUST BE AIR TIGHT PACKAGED,  
 MOISTURE CONTENT MUST BE 2.5±1%

CODIGO 1  
 CODING  
 ESCALA  
 SCALE 1:1

CODIGO 2  
 CODING  
 ESCALA  
 SCALE 1:1

CODIGO 3  
 CODING  
 ESCALA  
 SCALE 1:1

CODIGO 4  
 CODING  
 ESCALA  
 SCALE 1:1

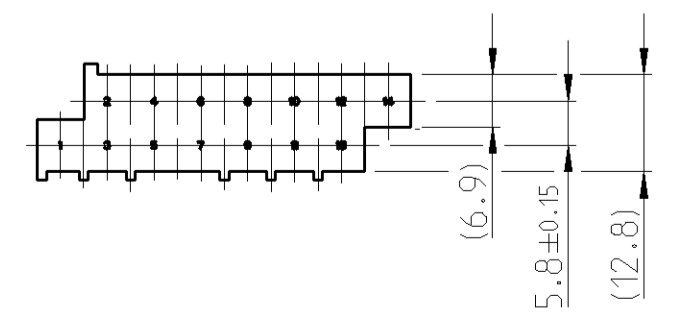
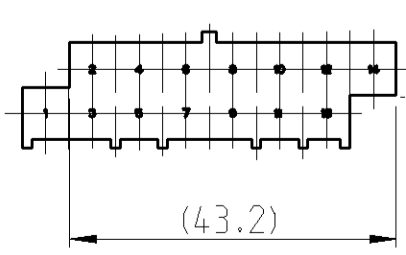
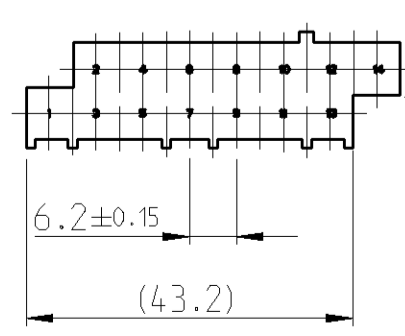
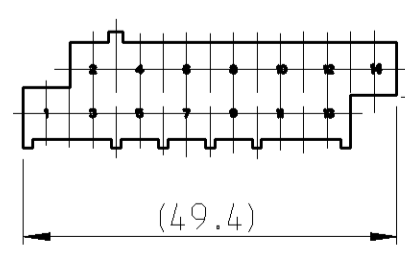

Code No.	Part Number	Material	Finish / Colour
CODE 4	365065-4	PA 6.6	YELLOW
CODE 3	365065-3	PA 6.6	BLACK
CODE 2	365065-2	PA 6.6	GREY
CODE 1	365065-1	PA 6.6	NATUR

THIS DRAWING IS A CONTROLLED DOCUMENT.

DIMENSIONS: mm	TOLERANCES UNLESS OTHERWISE SPECIFIED: 0 PLC ±± 1 PLC ±±± 2 PLC ±±±± ±0.2 3 PLC ±±±±± 4 PLC ±±±±±± ANGLES ±° FINISH	DWN R. ULLRICH 16NOV1984 CHK J. PASCUAL 15JUN1993 APVD L. BATILO 15JUN1993	TE Connectivity
MATERIAL SEE PART LIST	PRODUCT SPEC APPLICATION SPEC	NAME 14 POS. TAB-HOUSING	SIZE CAGE CODE DRAWING NO RESTRICTED TO A2 00779 C-365065
	WEIGHT CUSTOMER DRAWING	SCALE 2:1	SHEET 1 OF 1 REV G1